

124001811
BEST-LIFT FORKLIFT
ATTACHMENT



STAB



GRAB

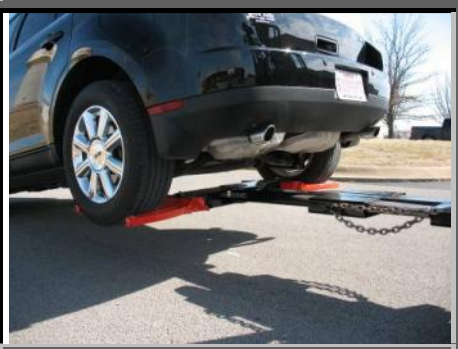





















LIFT



PUT IT WHERE YOU WANT

124001811 BEST-LIFT ATTACHMENTS

			
E900015 Forklift STINGER WELDMENT	E801000 CROSSBAR	0801073 MAIN PIVOT PIN	0306748 Bushing, Brass (Main Pivot)
			
			
0703640 Trust Washer	E900013 Driver Side Claw	E900014 Passenger Side Claw	E0701956 Pivot Pin Screw
			
			
E801008 AWS CLAW PIVOT	AWS-1011-A CLAW SPRING	AWS-1012-B TOWBAR SPRING	0400579 ROLL PIN 3/8" x 4"
			
			
AWS-1055-A THIN CLAW WASHER	AWS-1055-B THICK CLAW WASHER	E300002 BUSHING	E700030 WASHER - 1/2"
			

124001811 BEST-LIFT ATTACHMENT PARTS BREAK-OUT

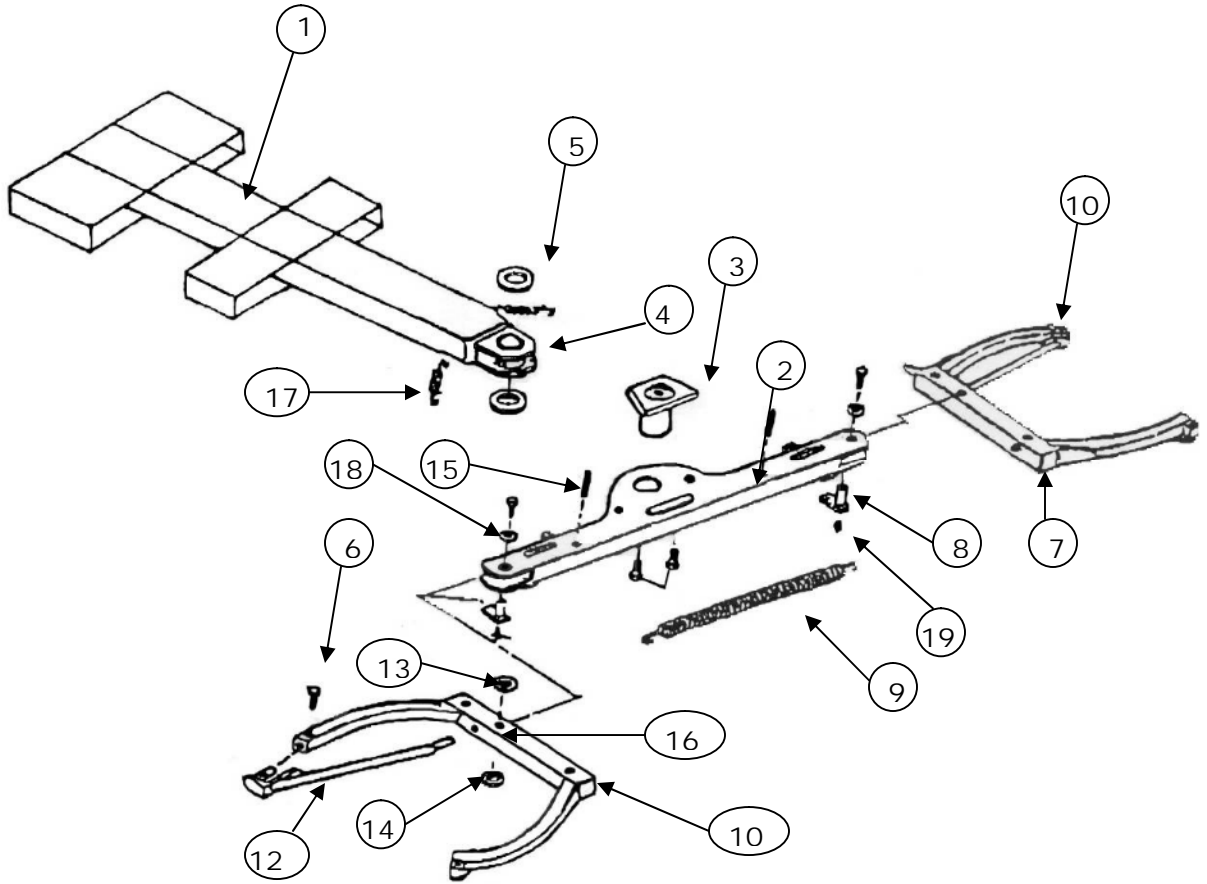

ITEM	NO. REQ.	PART NUMBER	DESCRIPTION	WT / LBS
1	1	E900015	FORKLIFT STINGER WELDMENT w/ 0306748	155.0
2	1	E801000	CROSSBAR	82.0
3	1	0801073	MAIN PIVOT PIN	8.0
4	1	0306748	BUSHING, BRASS (MAIN PIVOT PIN)	1.0
5	2	0703640	THRUST WASHERS	.025
6	2	0701956	PIVOT PIN SCREWS	.06
7	1	E900014	PASSENGER SIDE CLAW	34.0
8	2	E801008	CLAW PIVOT PINS	1.0
9	1	AWS-1011-A	CLAW SPRING (Large)	1.13
10	1	E900013	DRIVER SIDE CLAW	34.0
11	2	E801020P	TIRE ADAPTOR WELDMENT - RIGHT HAND	3.5
12	2	E801020D	TIRE ADAPTOR WELDMENT - LEFT HAND	3.5
13	2	AWS-1055-A	THIN CLAW SHIM	.03
14	2	AWS-1055-B	THICK CLAW SHIM	.03
15	2	0400579	3/8" x 4" ROLL PIN	.03
16	2	E300002	BUSHING	.40
17	2	AWS-1012-B	TOW BAR SPRING	.36
18	2	E700030	1/2" WASHER	.08
19	2	0300113	GREASE FITTING	.03