

FF3504A**FORD**
Front suspension package
Ensemble pour suspension avant
Ensemble para suspensión de delantero
INSTALLATION INSTRUCTIONS

- Raise vehicle allowing the axle to hang freely.
- Disconnect shock absorber from upper mount and retain hardware.
- Remove existing bump stop assembly.
- Remove two bottom OEM bolts on the shock mount & retain hardware.
- Assemble Aeon rubber spring and bracket as shown in the adjacent diagram.
- Mount Timbren assembly using OEM fasteners.
- Refasten shock absorber to upper mount.
- Lower vehicle.

INSTRUCTIONS DE MONTAGE

- Soulever le véhicule de sorte que l'essieu soit dégagé.
- Décrocher l'amortisseur de la coupelle supérieure et conserver le matériel.
- Retirer l'assemblage de la butée de suspension existante.
- Retirer les deux boulons inférieurs du fabricant d'équipement situés sur le support d'amortisseur et conserver le matériel.
- Assembler le ressort en caoutchouc Aeon et le support comme il est indiqué dans le schéma adjacent.
- Monter l'assemblage Timbren en utilisant la boulonnerie du fabricant d'équipement.
- Refixer l'amortisseur à la coupelle supérieure.
- Redescendre le véhicule.

INSTRUCCIONES DE INSTALACIÓN

- Levante el vehículo dejando que los ejes cuelguen libremente.
- Desconecte los amortiguadores de choque de la montura superior y de las piezas metálicas de retención.
- Retire la unidad del tope de suspensión existente.
- Retire los dos pernos del fabricante original de equipo inferiores montura antigolpes y de las piezas metálicas de retención.
- Ensamble el resorte de caucho Aeon y la abrazadera como se muestra en el diagrama adyacente.
- Monte la unidad Timbren utilizando elementos de sujeción del fabricante original de equipo.
- Vuelva a apretar el amortiguador de choque a la montura superior.
- Baje el vehículo.

Ref. = Reference = No. de référence = Núm. de referencia
Part = Part #. = No. de pièce = Núm. de pieza
Qty. = Quantity = Quantité = Cantidad

Ref	Part	Qty
1	K10221-003	2
2	A00530-65P30	2
3	F31003-250	2

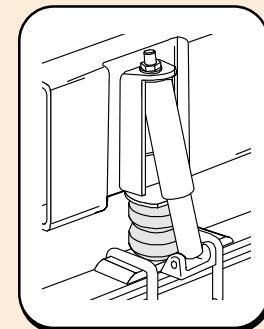
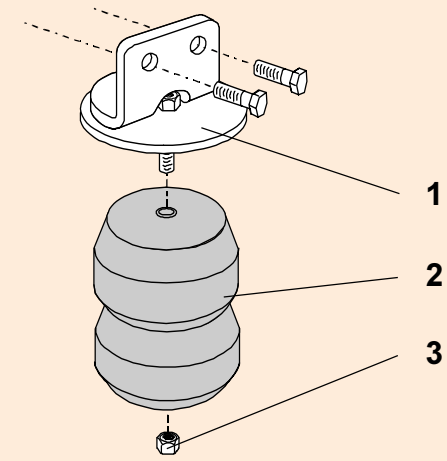

Do not exceed vehicle manufacturer's recommended axle weight rating. Check for AEON® interference with vehicle components - Under load AEON® will "expand" in diameter.

Ne pas dépasser le poids nominal sur l'essieu recommandé par le fabricant du véhicule. Vérifier que le ressort AEON® n'a pas d'incidence sur d'autres pièces du véhicule - Le ressort AEON® augmentera son diamètre avec la charge.

No exceda la carga nominal en el eje recomendada por el fabricante del vehículo. Compruebe que no haya interferencia entre el resorte AEON® y los otros componentes del vehículo. Bajo carga, el resorte AEON® se ampliará en diámetro.

FF3504A



FF3504A

TIMBREN INDUSTRIES INC.

www.timbren.com

PART NUMBER	DESCRIPTION	QTY	LOCATION
F31003-250	NYLOCK LOCKNUT 3/8 UNC GR 5 Z	2	G1B
A00530-65P30	Hollow Rubber Spring	2	C6A
K10221-003	FF2504A / FF3504A WELDMENT	2	D18D
B90200-CF	SMALL FRONT BOX - 9.5 x 7 x 5.5	1	A--E
B10000	8" x 12" BUBBLE FOR KITS	1	
B00029-010	BARCODE LABEL FOR KIT	1	

ASSEMBLY NOTES:

Issued: 11/6/2006

Clearance Instructions:

Rear SES Kits for Pick-Ups and Vans should have a 1/2" to 1-1/2" gap between the rubber spring and contact point when empty.

A partial load, or vehicle accessories will reduce or eliminate the gap.

Front SES kits are usually in full contact.

Medium and Heavy-Duty Trucks, Trailers and Motorhomes will be in constant contact, and have no gap.

Lifetime Warranty:

Timbren SES Kits are warranted against defects in material and workmanship, under normal use and service, for the life of the vehicle on which the kit was originally installed. The warranty is not transferable and proof of purchase is required. The warranty is limited to the replacement of the failed part.

TIMBREN will not be responsible for any labour or freight charges involved in the replacement of any product. TIMBREN shall be entitled to make its own inspection to determine the validity of the claim. TIMBREN shall not be liable nor warranty the product in the event of alteration, misuse, overload, negligence or damage caused by others.

If ride or performance of our product is unsatisfactory in any way, please call: 1-800-263-3113 or email sales@timbren.com