











## MINIBARS



## 5545 SERIES REFLEX<sup>®</sup> 11" Microbar

5545 Series LED microbars provide a super-compact yet powerful warning solution that offers the flexibility of either permanent or vacuum-magnet mounting. Featuring 12-24 VDC operation, the Reflex microbar uses high intensity LEDs to maximize light output. Users can select from 35 flash patterns, either via trigger wire on permanent mount models or cigarette plug on vacuum-magnet models.

### Models

| PART NO.  | MOUNT         | LENS COLOR  | LED COLOR   |
|-----------|---------------|---|---|
| 5545A     | 4 Bolt        |  A |  A |
| 5545CA    | 4 Bolt        |  C |  A |
| 5545A-VM  | Vacuum-Magnet |  A |  A |
| 5545CA-VM | Vacuum-Magnet |  C |  A |

### Features and Benefits

- 12-24 VDC, 0.7 Amps
- Four LED reflector modules, each containing six LEDs provide high intensity light output
- Choice of 35 flash patterns
- Cigarette plug with on/off and flash pattern selection switch (vacuum-magnet)
- Polycarbonate base & low profile lens

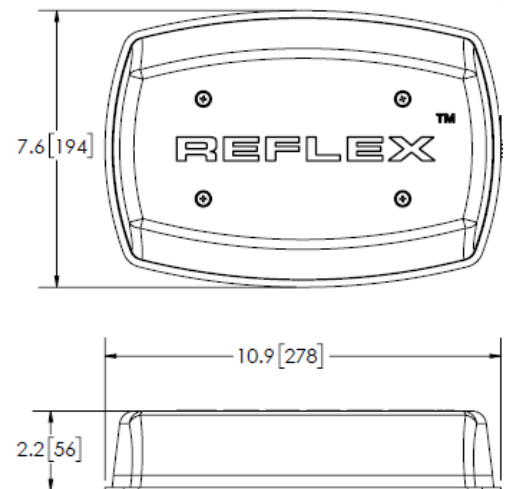

### Accessories / Replacements

- Domes: Amber - R5545LA  
Clear - R5545LC
- Mounting Feet: EZ5500BKT