



OWNER'S MANUAL

V30

INSTALLATION, OPERATION, MAINTENANCE & PARTS

**NOTE: MANUAL including SPECIFICATIONS, subject to change without notice
All ratings specified are based on structural factors only,
not vehicle capacities or capabilities.**



8503 Hilltop Drive
Ooltewah, Tennessee 37363
Phone (423) 238-7227 • FAX (423) 238-7237

FORM NO. 0501429
05 / 04
PRICE \$25.00

LIMITED WARRANTY

MILLER INDUSTRIES TOWING EQUIPMENT INC., hereinafter referred to as MILLER, warrants to the original purchaser that each new MILLER wrecker or other MILLER products will be free from defects in material and workmanship for a period of twelve (12) months from date placed in service, but in no event shall such warranty period exceed twenty-four (24) months from date of manufacture by MILLER. The purchaser must promptly notify MILLER in writing of any failure in material or workmanship. In no event shall MILLER accept such notification later than twenty-four (24) months from date of delivery or twelve (12) months from date placed in service, whichever is earlier.

MILLER's obligation under this warranty, statutory or otherwise, is limited to the repair or replacement at the MILLER factory, or at a point designated by MILLER, of such part or parts as shall appear upon inspection by MILLER to be defective in material or workmanship. New or remanufactured parts will be used for any replacement at MILLER's option. This warranty is not transferable. This warranty does not obligate MILLER to bear the cost of labor or transportation charges in connection with the repair or replacement of any parts found to be defective, nor shall it apply to a product upon which repairs or alterations have been made unless authorized by MILLER.

EXCEPT AS EXPRESSLY SET FORTH IN THIS WARRANTY, MILLER MAKES NO OTHER WARRANTY, EXPRESS OR IMPLIED, AND HEREBY DISCLAIMS ALL OTHER WARRANTIES INCLUDING, BUT NOT LIMITED TO, THE IMPLIED WARRANTIES OF MERCHANTABILITY AND FITNESS FOR A PARTICULAR PURPOSE. MILLER shall in no event be liable for claimed downtime, claimed loss of profits or goodwill, or any other special, incidental, indirect, or consequential damages concerning or relating to any product or parts, whether based on negligence, strict liability, breach of contract, breach of warranty, misrepresentation or any other legal theory, regardless of whether the loss resulted from any general or particular requirement which MILLER knew or had reason to know about at the time of sale.

MILLER MAKES NO WARRANTY, EXPRESS OR IMPLIED, AS TO THE FINISHED PRODUCTS MANUFACTURED OR SUPPLIED BY ANOTHER MANUFACTURER AND SUPPLIED BY MILLER TO PURCHASER, including, but not limited to, any vehicle to which a MILLER product may be affixed or any accessories or wire rope, and MILLER EXPRESSLY DISCLAIMS ANY IMPLIED WARRANTIES OF MERCHANTABILITY OR FITNESS FOR A PARTICULAR PURPOSE AS TO SUCH EQUIPMENT OR PRODUCTS. This language shall in no way affect or diminish the rights of the purchaser to rely on such warranties as are extended by such manufacturers or suppliers. MILLER shall, to the extent permitted under applicable law, pass on to the purchaser such manufacturer's or seller's warranty.

MILLER, whose policy is one of continuous improvement, reserves the right to improve its products through changes in design or materials as it may deem desirable without being obligated to incorporate such changes in products previously sold. This warranty is not intended to cover or include the following items, which are set forth by way of example and not limitation:

- A. Normal deterioration of trim, paint, lettering, and appearance items due to wear or exposure to weather, road conditions, road treatments, etc.
- B. Any damage or defect due to accident, misuse, abuse, improper or unauthorized repairs, failure to provide reasonable and necessary maintenance, or uses for which the equipment was not designed or intended.
- C. Alterations or modifications that affect performance, operation or reliability.
- D. Normal maintenance parts including, but not limited to, wear pads, bushings, wire rope, mud flaps, fenderettes, light bulbs, hydraulic oil, filters, and tow sling belts.

IT IS EXPRESSLY UNDERSTOOD THAT MILLER MAKES NO IMPLIED WARRANTY THAT MILLER PRODUCTS SHALL BE FIT FOR THE PURPOSE OF LIFTING OR MOVING PEOPLE OR FOR ANY OTHER IMPROPER USE.



Miller Industries Towing Equipment Inc.
8503 Hilltop Drive
Ooltewah, Tennessee 37363

Telephone (423) 238-7227

SERIAL NUMBER

Section VI - PARTS

This Section is provided by the manufacturer for the purpose of ordering any component part of the **VULCAN V30** that may be required when part replacement is necessary. Be certain to use only original equipment replacement parts for warranty purposes as well as for keeping your **VULCAN V30** in its original state and optimum operating capacities.

When ordering replacement or spare parts be sure to provide the following information to the manufacturer's **Parts Department**.

1. **Manual Number & Date of Publication**
2. **Manual Page Number**
3. **Page Title**
4. **Reference Number of Part Desired**
5. **Part Number**
6. **Part Description**
7. **Quantity of Part Desired**

Providing this information will help ensure that the correct parts will be delivered to you in an expedient manner without delay. Should additional information be required for repair or replacement of certain components, contact your Manufacturer Authorized Representative.

The Manufacturer reserves the right, without notice or obligation, to improve or modify their products, which may change the specifications, models and feature availability.

Section VI - PARTS (cont'd)

SUBFRAME ASSEMBLY

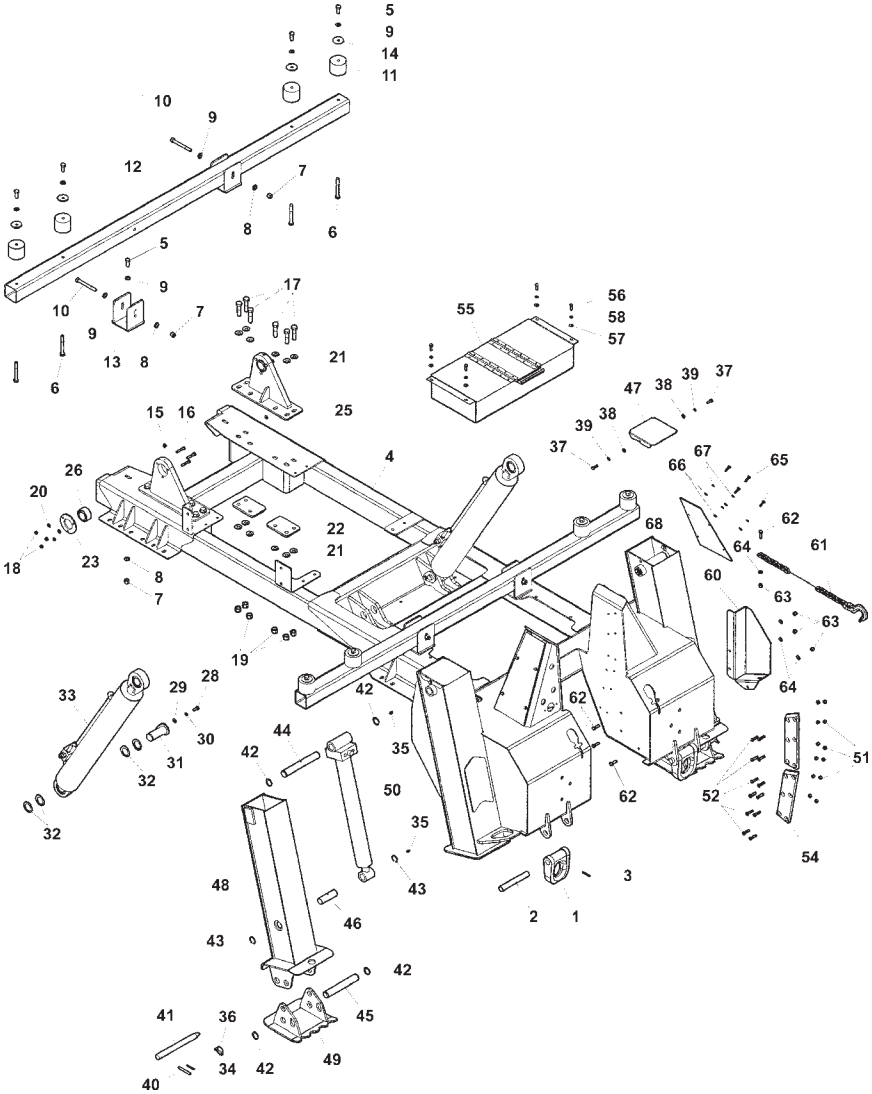

Section VI - PARTS (cont'd)

SUBFRAME ASSEMBLY

REF. NO.	NO. REQ'D	PART NUMBER	DESCRIPTION
--	--	0902842	KIT, 'D' RING
1	2	0712380	'D' RING
2	2	BA0259	PIN, 'D' RING
3	2	HD0106	SPRING PIN, 1/4" X 1-3/4"
4	1	3014-810000	SUBFRAME WELDMENT
--	--	3104-980011	BODY INSTALLATION KIT
5	12	0400177	SCREW, 1/2"-13 X 1-1/4" HEX HD CAP GR5
6	8	0400237	SCREW, 1/2"-13 X 4" HEX HD CAP GR5
7	8	0400408	NUT, 1/2"-13 HEX NYLOK
8	16	0400467	WASHER, 1/2" SAE HARDENED
9	8	0400491	LOCKWASHER, 1/2" HELICAL
10	4	9043830	SCREW, 1/2"-13 X 4-1/2" HEX HD CAP
11	8	9402970	TOOLBOX MOUNTING PAD
12	2	3012-791005	TUBE, BOX MOUNTING
13	4	3012-810300	BRACKET, BODY TUBE
14	8	0400498	WASHER, 1/2" ID X 2" OD X .150 FLAT
--	--	3014-991001	BOOM PIVOT ASSEMBLY
15	2	0301397	GREASE FITTING, 90°
16	6	9041108	SCREW, 5/16" NC X 1-3/4" HEX HD CAP GR8
17	12	0400262	SCREW, 5/8"-11 X 2-1/2" HEX HD CAP GR8
18	6	0400382	NUT, 5/16"-18 HEX NYLOK
19	12	0400421	NUT, 5/8"-11 HEX NYLOK
20	6	0400463	WASHER, 5/16" FLAT
21	24	0400506	WASHER, 5/8" FLAT
22	4	3012-710107	PLATE, WASHER
23	2	3012-780001	RETAINING RING PLATE
24	1	3012-810400	PIVOT BLOCK WELDMENT, LH
25	1	3012-810500	PIVOT BLOCK WELDMENT, RH
26	2	561-2502001	BEARING, 2-1/2" SPHERICAL PLAIN
--	--	3014-991004	LIFT CYLINDER ASSEMBLY
27	2	0300113	GREASE FITTING, 1/4"-28 STRAIGHT
28	2	0400141	SCREW, 3/8"-16 X 7/8" HEX HD CAP GR5
29	8	0400479	SHIM, 1-1/2" ID X 2-1/8" OD X 1/8"
30	2	0400480	WASHER, 3/8" FLAT
31	2	0400482	LOCKWASHER, 3/8" HELICAL
32	2	3012-801000	PIN WELDMENT, LIFT CYLINDER
33	2	511-4000001	CYLINDER, BOOM LIFT
--	--	3014-991005	JACK ASSEMBLY
34	2	HD0106	SPRING PIN, 1/4" X 1-3/4"
35	2	0300113	GREASE FITTING, 1/4"-28 STRAIGHT
36	2	0302474	LYNCH PIN
37	4	0400109	SCREW, 5/16"-18 X 1" HEX HD CAP GR5

REF. NO.	NO. REQ'D	PART NUMBER	DESCRIPTION
38	4	0400463	WASHER, 5/16" FLAT
39	4	0400464	LOCKWASHER, 5/16" HELICAL
40	2	0400568	ROLL PIN, 3/8" X 3"
41	2	0712504	PIN, RETAINING
42	8	9056125	RETAINING RING, 1-1/4" NOM HEAVY DUTY
43	4	9057125	SNAP RING, 1-1/4" NOM INTERNAL
44	2	810350002	PIN, UPPER TILT CYLINDER
45	2	1616030001	PIN, EXTENSION CYLINDER
46	2	3014-700001	PIN, SPADE EXTENSION CYLINDER (ROD)
47	2	3014-791003	COVER, JACK
48	2	3014-810600	INNER SPADE WELDMENT
49	2	3014-810700	FLIPPER WELDMENT, SPADE
50	2	511-2500001	CYLINDER, JACK LEG
--	--	3014-991006	BOOM WEAR PAD ASSEMBLY
51	24	0400382	NUT, 5/16"-18 HEX NYLOK
52	24	9043973	SCREW, 5/16"-18 X 1-1/2" FL HD SKT
53	2	806300005	BOOM GUIDE PAD, BODY ASSY LH
54	2	806300006	BOOM GUIDE PAD, BODY ASSY RH
55	--	3014-991007	REAR TRAY ASSEMBLY
--	24	0400004	NUT, #8-32 HEX NYLOK SS
--	24	0400015	SCREW, #8-32 X 1/2" FL HD PH MACH
56	4	0400109	SCREW, 5/16"-18 X 1" HEX HD CAP GR5
--	4	0400446	WELDNUT, 5/16"-18
--	24	0400450	WASHER, 10 SAE FLAT
57	4	0400451	WASHER, 1/4" FLAT
58	4	0400464	LOCKWASHER, 5/16" HELICAL
--	2	3012-791601	PLATE, BOX DOOR
--	1	3012-810600	REAR TRAY WELDMENT
--	2	3014-791005	PIANO HINGE, 12" LONG
--	--	3014-991009	CHAIN BOX ASSEMBLY
59	1	3012-791010	PANEL, CHAIN BOX LH
60	1	3012-791011	PANEL, CHAIN BOX RH
--	--	0903275	SAFETY CHAIN KIT
61	2	0307383	CHAIN ASSEMBLY, 5/16" G7 X 12'
62	8	0400122	SCREW, 3/8"-16 X 1-1/4" HEX HD CAP
63	8	0400392	NUT, 3/8"-16 HEX NYLOK
64	8	0400480	WASHER, 3/8" FLAT
--	--	3014-991010	COVER PLATE ASSEMBLY
65	8	0402021	SCREW, 1/4"-20 X 1" HEX HD CAP SS
66	8	0402110	WASHER, 1/4" FLAT SS
67	8	0402111	LOCKWASHER, 1/4" HELICAL SS
68	2	3014-791004	COVER PLATE

Section VI - PARTS (cont'd)

BODY ASSEMBLY

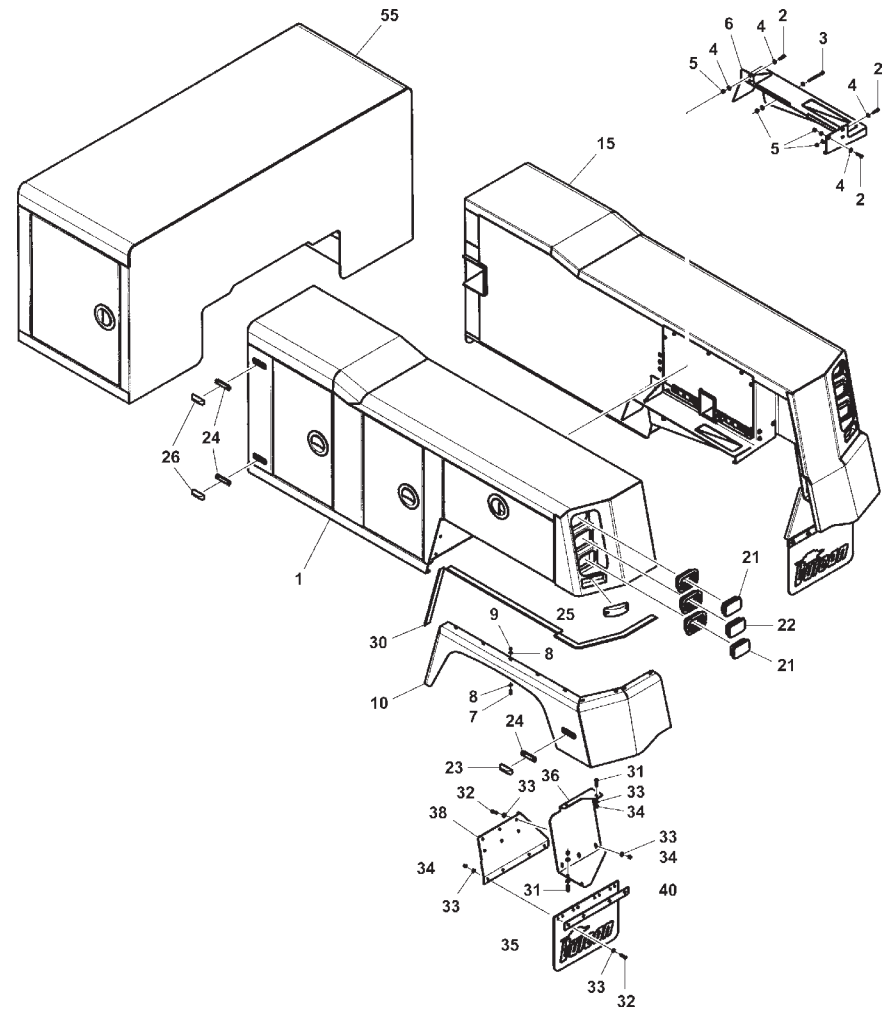

Section VI - PARTS (cont'd)

BODY ASSEMBLY

REF. NO.	NO. REQ'D	PART NUMBER	DESCRIPTION
1	1	3014-974000	LH BODY ASSEMBLY, SS
--	--	3014-974400	SPLASH GUARD ASSEMBLY, LH
2	6	0402043	SCREW, 3/8"-16 X 1-1/4" HEX HD CAP SS
3	1	0402053	SCREW, 3/8"-16 X 4-1/2" HEX HD CAP SS
4	14	0402120	WASHER, 3/8" FLAT 316 SS
5	7	0402123	NUT, 3/8"-16 HEX NYLOK SS
6	1	3014-874400	SPLASH GUARD WELDMENT, LH
--	--	3014-974800	FENDER KIT, LH
7	12	0402021	SCREW, 1/4"-20 X 1" HEX HD CAP SS
8	24	0402110	WASHER, 1/4" FLAT SS
9	12	0402113	NUT, 1/4"-20 HEX NYLOK SS
10	1	3014-874800	FENDERETTE PANEL WELDMENT, LH
--	--	3014-974900	FENDER KIT, RH
11	12	0402021	SCREW, 1/4"-20 X 1" HEX HD CAP SS
12	24	0402110	WASHER, 1/4" FLAT SS
13	12	0402113	NUT, 1/4"-20 HEX NYLOK SS
14	1	3014-874900	FENDERETTE PANEL WELDMENT, RH
15	1	3014-975000	RH BODY ASSEMBLY, SS
--	--	3014-975400	SPLASH GUARD ASSEMBLY, RH
16	6	0402043	SCREW, 3/8"-16 X 1-1/4" HEX HD CAP SS
17	1	0402053	SCREW, 3/8"-16 X 4-1/2" HEX HD CAP SS
18	14	0402120	WASHER, 3/8" FLAT 316 SS
19	7	0402123	NUT, 3/8"-16 HEX NYLOK SS
20	1	3014-875400	SPLASH GUARD WELDMENT, RH
--	--	3014-980006	LIGHT KIT, VULCAN V30
21	4	0307215	LIGHT, RED 45 STT LED
22	2	0307216	LIGHT, AMBER 45 TURN LED
23	2	0307217	LIGHT, RED LED RECTANGULAR 4" X 1"
24	6	0307218	BASE MOUNT FOR LIGHT, BLACK
25	2	0307219	LIGHT, RED LED RECTANGULAR 2" X 6"
26	4	0307365	LIGHT, AMBER LED RECTANGULAR 4" X 1.18"
27	6	9025049	INTERIOR & COMPARTMENT LIGHT W/SWITCH

REF. NO.	NO. REQ'D	PART NUMBER	DESCRIPTION
--	--	3014-980016	BODY RUBBER KIT, V30
28	16 FT.	9032096	DECORATIVE TRIM
29	60 FT.	9032157	RUBBER SEAL
30	16 FT.	9061802	RUBBER STRIP
--	--	3014-980017	MUD FLAP KIT, V30
31	4	0402043	SCREW, 3/8"-16 X 1-1/4" HEX HD CAP SS
32	14	0402044	SCREW, 3/8"-16 X 1-1/2" HEX HD CAP SS
33	40	0402120	WASHER, 3/8" FLAT 316 SS
34	22	0402123	NUT, 3/8"-16 HEX NYLOK SS
35	2	891000001	MUD FLAP, RUBBER
36	1	3014-797020	MUD GUARD, LH
37	1	3014-797021	MUD GUARD, RH
38	1	3014-797022	MUD FLAP BRACKET, LH
39	1	3014-797023	MUD FLAP BRACKET, RH
40	2	3014-797024	BACK UP STRIP, MUD FLAP
--	--	6012-070000	24" SS TUNNEL BOX ASSEMBLY
41	20	0302433	CABLE TIE
42	1	0303385	JUNCTION BOX, 10 POLE
43	1	8909024	880 BOX KIT FOR SS TUNNEL BOX
44	2	9025049	INTERIOR & COMPARTMENT LIGHT W/SWITCH
45	20 FT.	9032157	RUBBER SEAL
46	2	526-3014010	WIRING HARNESS, TUNNEL BOX LIGHT
47	1	6012-970000	24" SS TUNNEL BOX
48	4	GV57	RUBBER GROMMET
--	--	6012-071000	36" SS TUNNEL BOX ASSEMBLY
49	20	0302433	CABLE TIE
50	1	0303385	JUNCTION BOX, 10 POLE
51	1	8969025	896 SS SPACER BOX KIT, 36" TUNNEL
52	2	9025049	INTERIOR & COMPARTMENT LIGHT W/SWITCH
53	24 FT.	9032157	RUBBER SEAL
54	2	526-3014010	WIRING HARNESS, TUNNEL BOX LIGHT
55	1	6012-971000	36" SS TUNNEL BOX
56	4	GV57	RUBBER GROMMET

Section VI - PARTS (cont'd)

RECOVERY BOOM ASSEMBLY

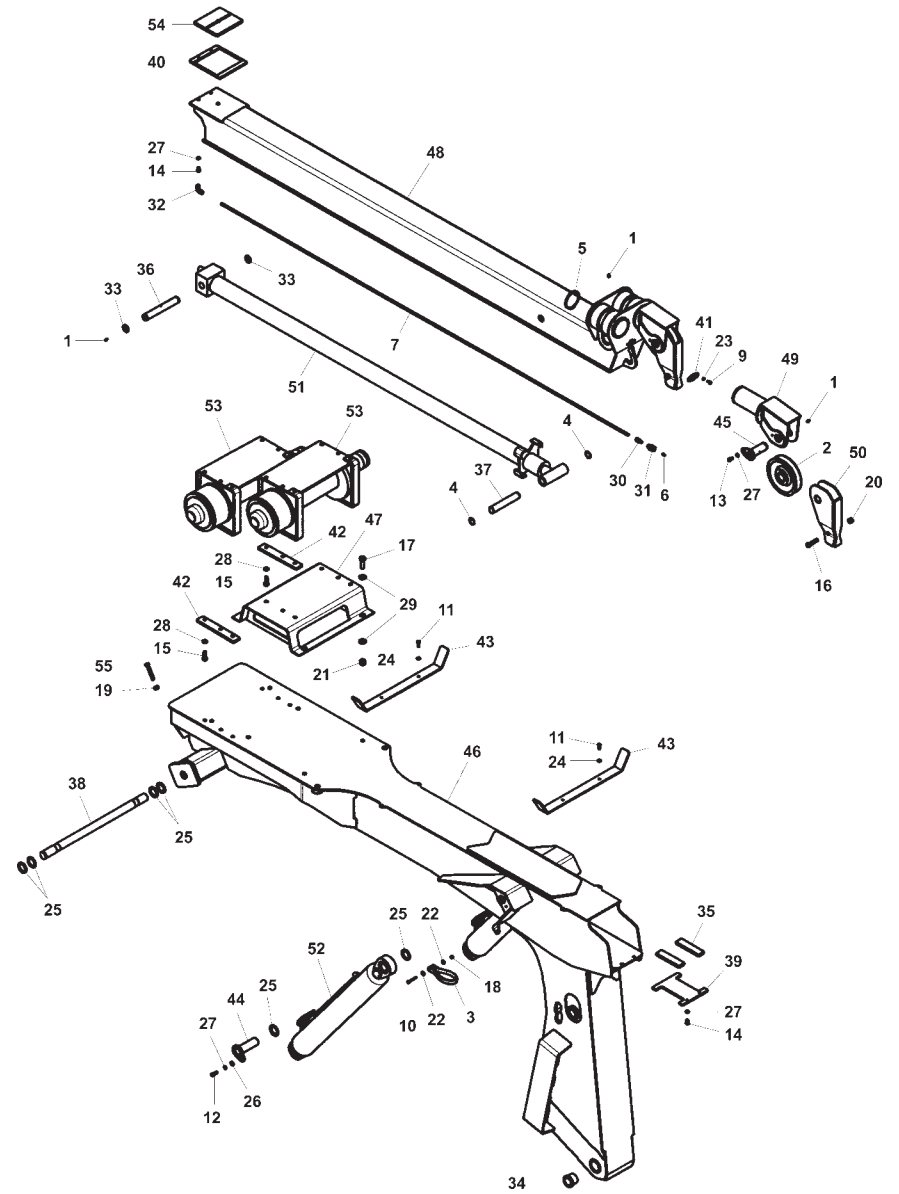

Section VI - PARTS (cont'd)

RECOVERY BOOM ASSEMBLY

REF. NO.	NO. REQ'D	PART NUMBER	DESCRIPTION
1	5	0300113	GREASE FITTING, 1/4"-28 STR
2	2	0300626	SHEAVE, 8"
3	2	0301533	TIE DOWN STRAP, 15"
4	2	0301642	SNAP RING, 1-1/4"
5	2	0301814	RETAINING RING, 3-1/2" EXTERNAL
6	1	0301895	GREASE FITTING, 1/8" STR
7	9.2 FT.	0301949	SYNFLEX HOSE, 3/8"
8	2	0302848	WIRE ROPE, 1/2" X 150'
9	2	0400059	SCREW, 1/4"-20 X 5/8" HEX HD CAP
10	2	0400078	SCREW, 1/4"-20 X 2" HEX HD CAP
11	4	0400103	SCREW, 5/16"-18 X 1-1/4" HEX HD CAP
12	2	0400126	SCREW, 3/8"-16 X 1" HEX HD CAP
13	2	0400147	SCREW, 3/8"-16 X 5/8" HEX HD CAP
14	4	0400149	SCREW, 3/8"-24 X 5/8" HEX HD CAP
15	12	0400181	SCREW, 1/2"-13 X 1-1/2" HEX HD CAP
16	2	0400184	SCREW, 1/2"-13 X 2-1/4" HEX HD CAP
17	4	0400260	SCREW, 5/8"-11 X 2" HEX HD CAP
18	2	0400367	NUT, 1/4"-20 HEX NYLOK
19	2	0400407	NUT, 1/2"-13 HEX
20	2	0400408	NUT, 1/2"-13 HEX NYLOK
21	4	0400421	NUT, 5/8"-11 HEX NYLOK
22	4	0400451	WASHER, 1/4" FLAT
23	2	0400452	LOCKWASHER, 1/4" HELICAL
24	4	0400463	WASHER, 5/16" FLAT
25	8	0400479	WASHER, 1.510 I.D. X 2.125 O.D. X .125
26	2	0400480	WASHER, 3/8" FLAT
27	8	0400482	LOCKWASHER, 3/8" HELICAL
28	12	0400491	LOCKWASHER, 1/2" HELICAL

REF. NO.	NO. REQ'D	PART NUMBER	DESCRIPTION
29	8	0400506	WASHER, 1/2" FLAT
30	1	9012549	CONNECTOR, 3/8" TUBE X 1/8" NPT
31	1	9012552	BULKHEAD COUPLING, 1/8"
32	1	9012584	ELBOW, 1/4" NPT X 3/8" TUBE 90
33	2	9056125	RETAINING RING, 1-1/4" NOM HEAVY DUTY
34	2	806510001	FLANGE BEARING
35	2	880060002	NYLATRON PAD
36	1	897400001	FRONT PIN
37	1	897400002	REAR PIN
38	1	3012-700001	PIN, MAIN BOOM PIVOT
39	1	3012-792001	PLATE, PAD CAGE
40	1	3012-792002	PLATE, PAD CAGE
41	1	3012-793001	LUBRICATOR MOUNTING PLATE
42	4	3014-791001	WASHER PLATE, 14K
43	2	3014-792001	CABLE WING
44	2	3014-801000	PIN WELDMENT
45	2	3014-802000	PIN WELDMENT
46	1	3014-820000	BOOM WELDMENT, MAIN RECOVERY
47	1	3014-821000	BRACKET WELDMENT
48	1	3014-830000	INNER BOOM WELDMENT
49	2	3014-831000	SHEAVE WELDMENT, 3014
50	2	3014-831100	SWIVEL GUIDE WELDMENT
51	1	511-3000001	BOOM EXTENSION CYLINDER
52	2	511-4000001	CYLINDER, BOOM LIFT
53	2	514-1501101	WINCH, 15K DP
54	1	535-0500001	NYLATRON PAD
55	2	541-5050219	SCREW, 1/2"-13 X 3" HEX HD CAP FULL THRD

Section VI - PARTS (cont'd) UNDERLIFT ASSEMBLY

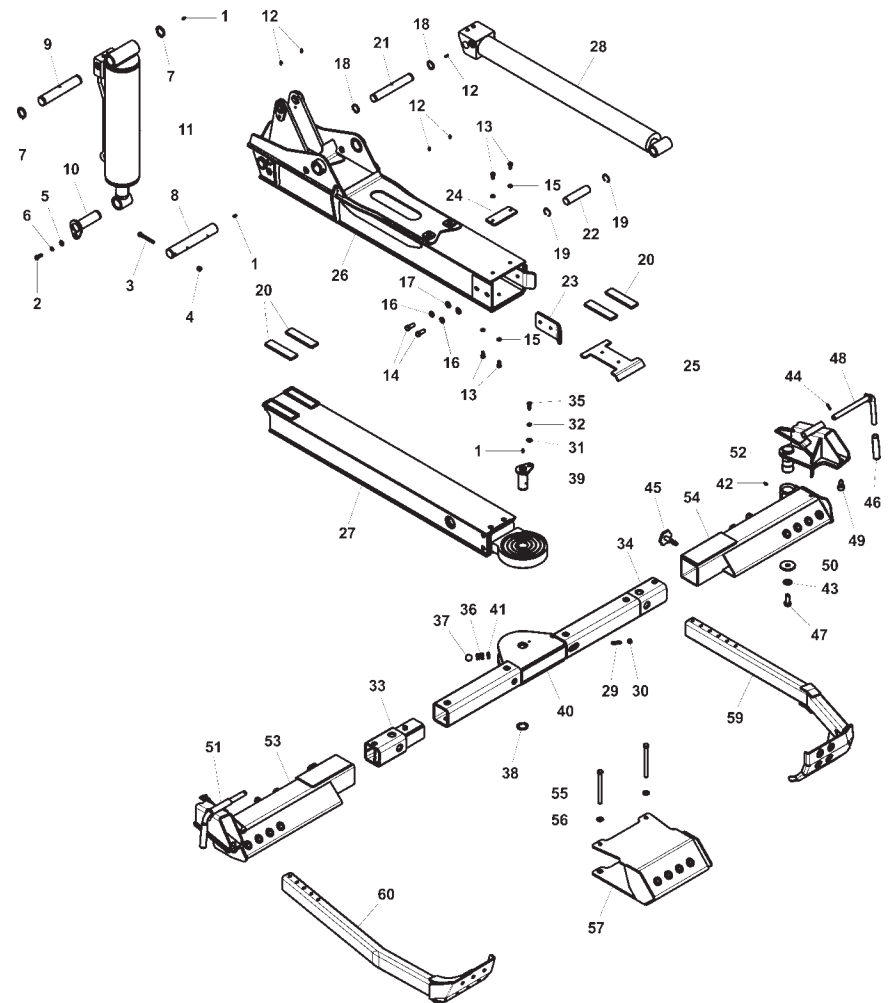

Section VI - PARTS (cont'd)

UNDERLIFT ASSEMBLY

REF. NO.	NO. REQ'D	PART NUMBER	DESCRIPTION
1	5	0300113	GREASE FITTING, 1/4"-28 STRAIGHT
2	1	0400126	SCREW, 3/8"-16 X 1" HEX HD CAP GR5
3	1	0400133	SCREW, 3/8"-16 X 3" HEX HD CAP GR5
4	1	0400392	NUT, 3/8"-16 HEX NYLOK
5	1	0400480	WASHER, 3/8" FLAT
6	1	0400482	LOCKWASHER, 3/8" HELICAL
7	2	9056150	RETAINING RING, 1-1/2" HEAVY DUTY
8	1	3012-700002	PIN, STINGER
9	1	3014-700002	PIN, FOLD CYLINDER BASE
10	1	3014-801000	PIN WELDMENT
11	1	511-5000001	CYLINDER, UNDERLIFT FOLD
--	--	3014-940000	UNDERLIFT BOOM ASSEMBLY
12	5	0300113	GREASE FITTING, 1/4"-28 STRAIGHT
13	4	0400121	SCREW, 3/8"-16 X 3/4" HEX HD CAP GR5
14	4	0400218	SCREW, 1/2"-20 X 1-1/4" HEX HD CAP GR5
15	4	0400482	LOCKWASHER, 3/8" HELICAL
16	4	0400491	LOCKWASHER, 1/2" HELICAL
17	4	0400492	WASHER, 1/2" FLAT
18	2	9056125	RETAINING RING, 1-1/4" NOM HEAVY DUTY
19	2	9057125	RETAINING RING, 1-1/4" NOM INT.
20	4	896040002	NYLATRON PAD
21	1	897400001	FRONT PIN
22	1	3012-700003	PIN, UNDERLIFT EXT (ROD)
23	2	3012-794002	PLATE, CROSSBAR POSITIONING
24	1	3012-794003	BAR, SPACER
25	1	3012-794004	PLATE, U/L PAD CAGE
26	1	3014-840000	U/L OUTER BOOM WELDMENT
27	1	3014-850000	U/L INNER BOOM WELDMENT
28	1	511-3000002	CYLINDER, UNDERLIFT EXTEND
--	--	3014-960000	CROSSBAR ASSEMBLY
29	1	0400139	SCREW, 3/8"-16 X 1-1/2" HEX SKT SET
30	1	0400392	NUT, 3/8"-16 HEX NYLOK
31	1	0400480	WASHER, 3/8" FLAT
32	1	0400482	LOCKWASHER, 3/8" HELICAL

REF. NO.	NO. REQ'D	PART NUMBER	DESCRIPTION
--	--	3014-960000	CROSSBAR ASSEMBLY (cont'd)
33	1	0907875	CROSSBAR END ASSEMBLY, LH
34	1	0907876	CROSSBAR END ASSEMBLY, RH
35	1	9041205	SCREW, 3/8"-16 X 1" HEX HD CAP GR8
36	1	9047057	DIE SPRING
37	1	9052013	BALL, 1" CHROME
38	1	9056150	RETAINING RING, 1-1/2" HEAVY DUTY
39	1	3012-801100	PIN WELDMENT, CROSSBAR PIVOT
40	1	3012-860000	CROSSBAR WELDMENT
41	1	3014-796005	SPACER, CROSSBAR DIE SPRING
--	--	3014-960200	CROSSBAR KIT, V30
42	2	0300113	GREASE FITTING, 1/4"-28 STRAIGHT
43	2	0400505	WASHER, 5/8" FLAT
44	2	0400559	ROLL PIN, 3/16" X 1"
45	2	8601900	SLIDE LOCK HANDLE KNOB ASSEMBLY
46	2	9032158	RUBBER HAND GRIP
47	2	9043950	SCREW, 5/8"-11 X 1-1/2" HEX HD CAP GR8
48	2	880411600	FRONT STOP PIN ASSEMBLY
49	2	896380001	SCOOP RETAINING PIN
50	2	896380002	SCOOP WASHER
51	1	896380500	SCOOP BRACKET WELDMENT, LH
52	1	896387500	SCOOP BRACKET WELDMENT, RH
53	1	3014-860200	OUTER CROSSTUBE, LT
54	1	3014-860300	OUTER CROSSTUBE, RT
--	--	896001000	CAR RETAINER KIT
55	4	0400180	SCREW, 1/2"-13 X 6" HEX HD CAP
56	4	0400492	WASHER, 1/2" FLAT
57	2	896395100	WHEEL SPACER WELDMENT
58	1	896610000	LIGHT WHEEL RETAINER, LH
59	1	896617000	LIGHT WHEEL RETAINER, RH
60	1	896390000	WHEEL RETAINER, LH
61	1	896397000	WHEEL RETAINER, RH

Section VI - PARTS (cont'd)

RECOVERY BOOM HYDRAULICS

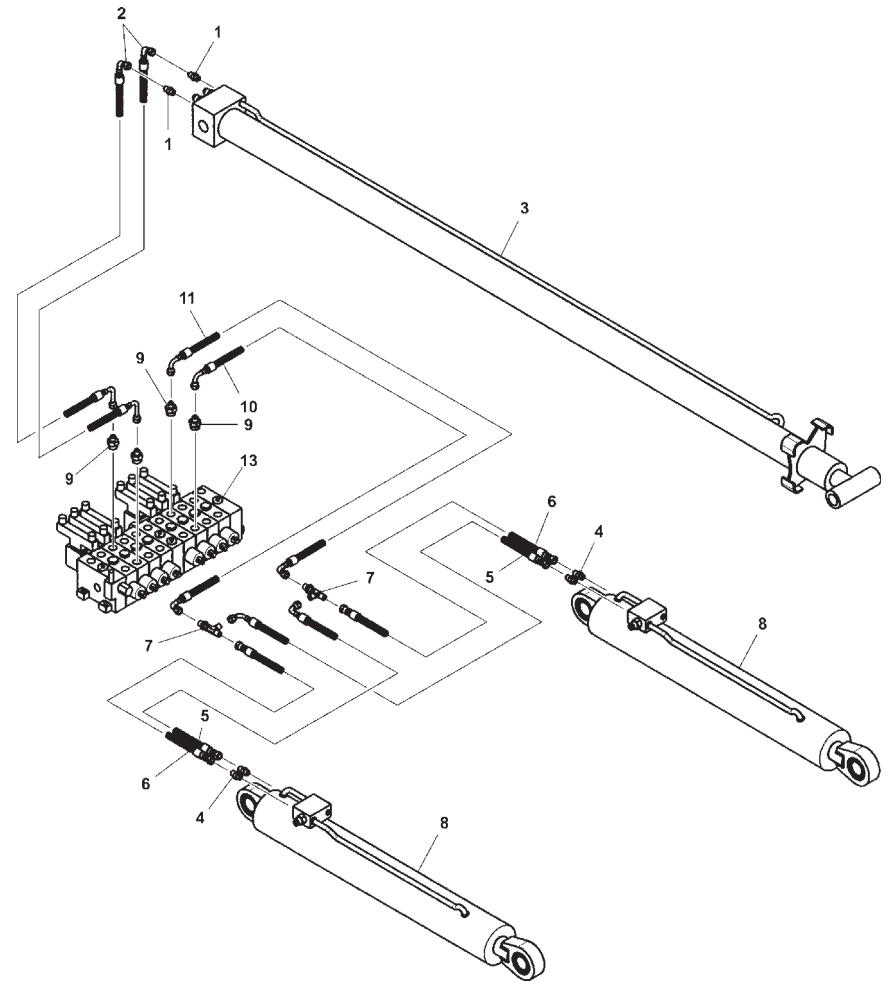

Section VI - PARTS (cont'd)

RECOVERY BOOM HYDRAULICS

REF. NO.	NO. REQ'D	PART NUMBER	DESCRIPTION
--	--	3014-920000	RECOVERY BOOM ASSEMBLY
1	2	0301522	CONNECTOR, 6MJ-6MB
2	2	0302605	HOSE ASSEMBLY, 44"
3	1	511-3000001	BOOM EXTENSION CYLINDER
--	--	3014-991004	LIFT CYLINDER
4	4	0301522	CONNECTOR, 6MJ-6MB
5	2	0301998	HOSE ASSEMBLY, 24"
6	2	0302000	HOSE ASSEMBLY, 24"
7	2	0302575	BULKHEAD RUN TEE, 6MJ-6BLKHD-6MJ W/NUT
8	2	511-4000001	CYLINDER, BOOM LIFT
--	--	3014-991015	MANUAL VALVE ASSEMBLY
9	4	0301778	CONNECTOR, 6MJ-10MB
10	1	0302604	HOSE ASSEMBLY, 44"
11	1	0302926	HOSE ASSEMBLY, 29"
12	1	3012-810700	BULKHEAD BRACKET WELDMENT (N.S.)
13	1	512-0883000	VALVE, P70

Section VI - PARTS (cont'd)

UNDERLIFT HYDRAULICS

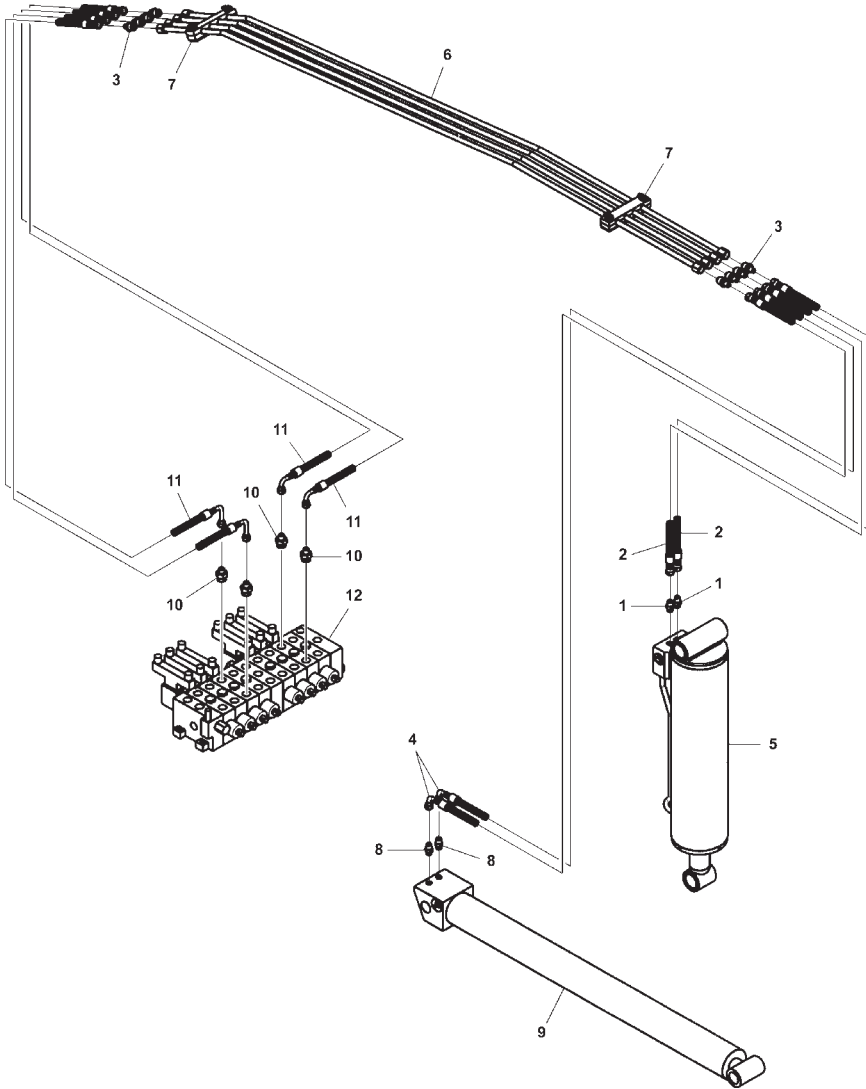

Section VI - PARTS (cont'd)

UNDERLIFT HYDRAULICS

REF. NO.	NO. REQ'D	PART NUMBER	DESCRIPTION
--	--	3014-920000	RECOVERY BOOM ASSEMBLY
1	2	0301522	CONNECTOR, 6MJ-6MB
2	2	0302035	HOSE ASSEMBLY, 18"
3	8	0302514	ADAPTER, 8MJ-6MJ
4	2	0303170	HOSE ASSEMBLY, 75"
5	1	511-5000001	CYLINDER, UNDERLIFT TILT
6	4	516-0807801	TUBE ASSEMBLY, UNDER BOOM
7	2	566-0840000	CLAMP SET, 4-TUBE
--	--	3014-940000	UNDERLIFT BOOM ASSEMBLY
8	2	0301522	CONNECTOR, 6MJ-6MB
9	1	511-3000002	CYLINDER, UNDERLIFT EXTEND
--	--	3014-991015	MANUAL VALVE ASSEMBLY
10	4	0301778	CONNECTOR, 6MJ-10MB
11	4	0302604	HOSE ASSEMBLY, 44"
12	1	512-0883000	VALVE, P70

Section VI - PARTS (cont'd)

PUMP, VALVE & FILTER HYDRAULICS

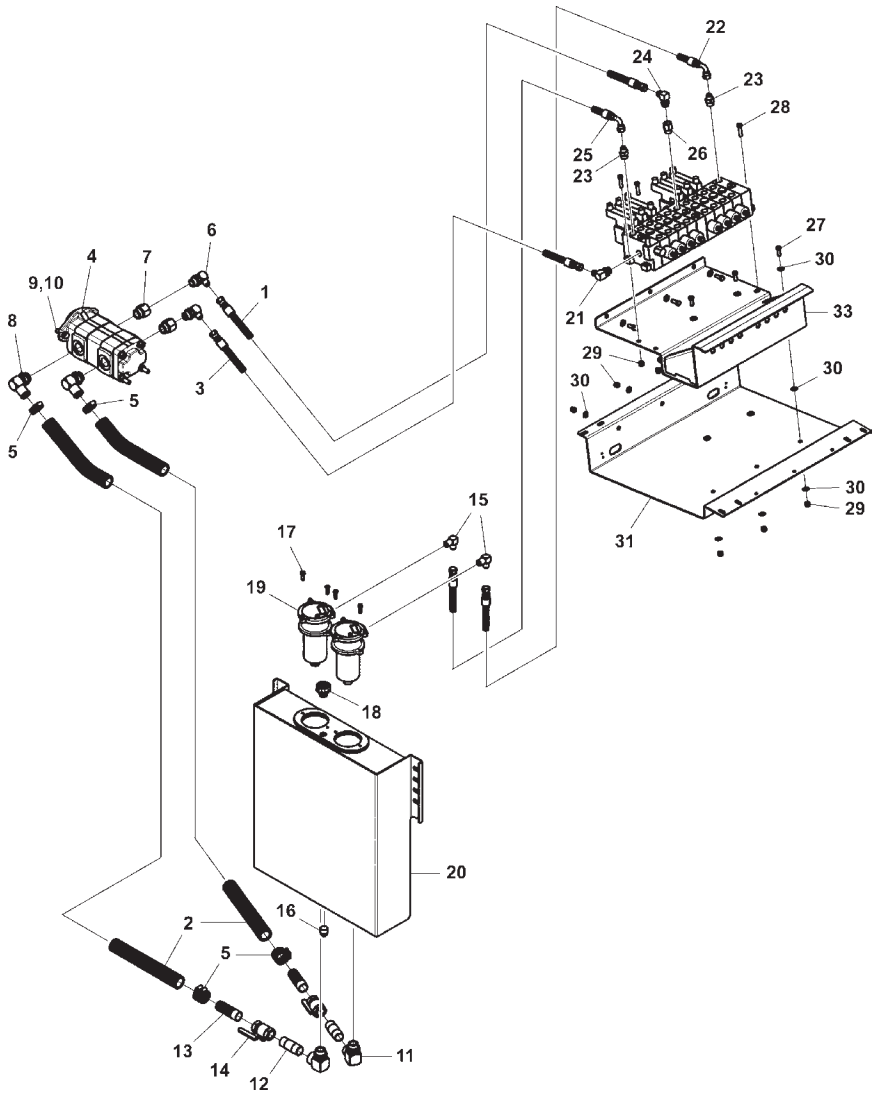

Section VI - PARTS (cont'd)

PUMP, VALVE & FILTER HYDRAULICS

REF. NO.	NO. REQ'D	PART NUMBER	DESCRIPTION
1	1	0301659	HOSE ASSEMBLY, 150"
2	28 FT.	0302756	SUCTION HOSE, 1-1/4" ID 100R4
3	1	0303762	HOSE ASSEMBLY, 120"
4	1	0303867	PUMP, BI-ROTATIONAL
--	--	0904545	KIT, PUMP FITTINGS
5	4	0300364	HOSE CLAMP, 7/8" TO 2-3/4"
6	2	0301547	ELBOW, 8MJ-12MB90
7	2	0302906	ADAPTER, 16MB-12FB
8	2	0306539	HOSE BARB, 20HOSE-16MB90
9	2	0400181	SCREW, 1/2"-13 X 1-1/2" HEX HD CAP GR5
10	2	0400491	LOCKWASHER, 1/2" HELICAL
--	--	3014-991008	KIT - HYD. TANK PARTS
11	2	0300692	ELBOW, 1 90 DEG STREET
12	2	0302959	NIPPLE, 1" NPT X 3" LG
13	2	9012927	NIPPLE, COMBINATION 1" NPT X 1-1/4" BARB
14	2	HC1338	BALL VALVE, 1" BRASS
--	--	3012-991011	HYD. TANK ASSEMBLY
15	2	0301371	ELBOW, 8MJ-12MP90
16	1	0303155	PIPE PLUG, 3/4" MAGNETIC
17	4	0400109	SCREW, 5/16"-18 X 1" HEX HD CAP
18	1	9018131	BREATHER CAP
19	2	9018399	IMMERSION FILTER ASSEMBLY
20	1	3012-880100	HYD. TANK WELDMENT
--	--	3014-991015	MANUAL VALVE ASSEMBLY
21	1	0300052	ELBOW, 8MJ-10MB90
22	1	0300787	HOSE ASSEMBLY, 53"
23	2	0301376	CONNECTOR, 8MJ-10MB
24	1	0301388	ELBOW, 8MJ-8MB90
25	1	0302313	HOSE ASSEMBLY, 25"
26	1	0303176	CONNECTOR, 10MB-8FB
27	6	0400126	SCREW, 3/8"-16 X 1" HEX HD CAP GR5
28	3	0400132	SCREW, 3/8"-16 X 1-1/2" HEX HD CAP GR5
29	6	0400392	NUT, 3/8"-16 NYLOK HEX
30	15	0400480	WASHER, 3/8" FLAT
31	1	3014-791010	PANEL - VALVE MOUNTING
32	1	3014-791011	PANEL - VALVE COVER (NOT SHOWN)
33	1	3014-810200	VALVE BRACKET WELDMENT
34	1	512-0883000	VALVE, P70

Section VI - PARTS (cont'd)

WINCH HYDRAULICS

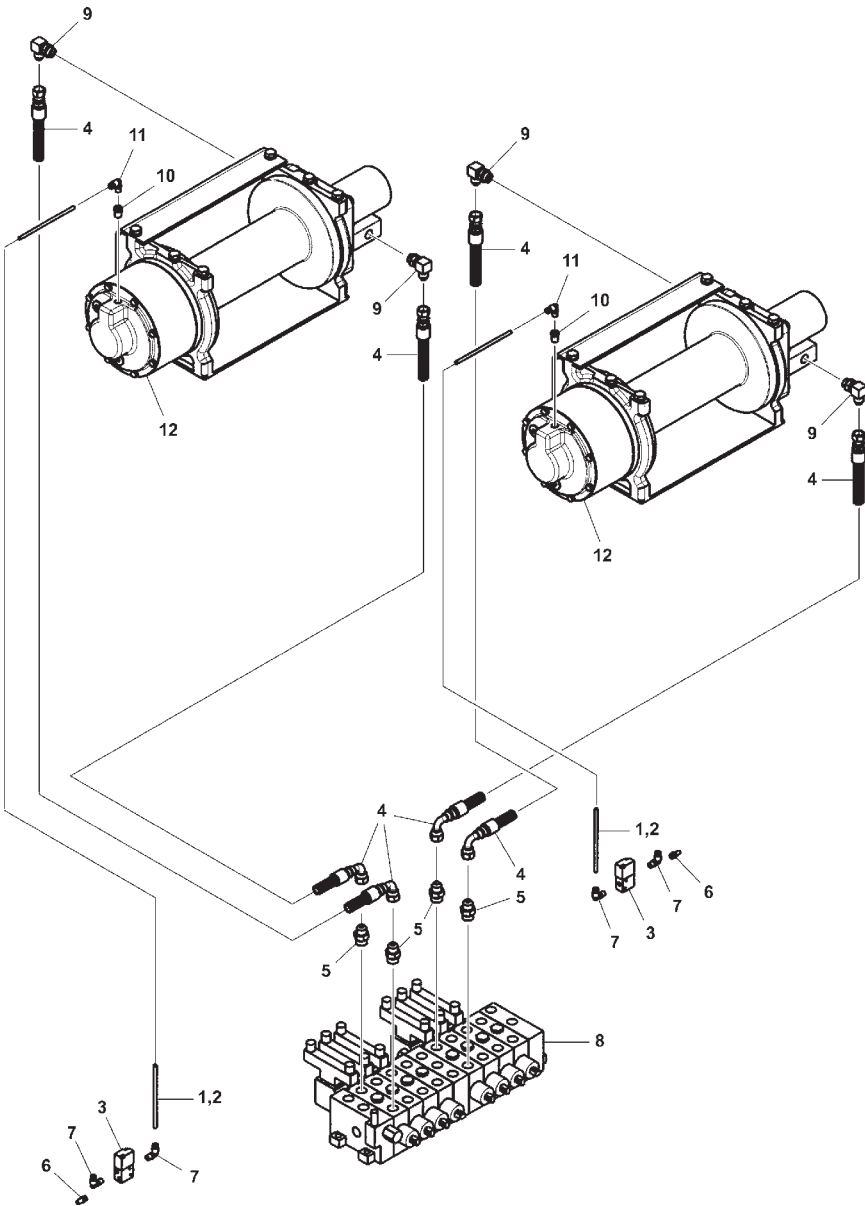

Section VI - PARTS (cont'd)

WINCH HYDRAULICS

REF. NO.	NO. REQ'D	PART NUMBER	DESCRIPTION
1	20 FT.	0301577	PLASTIC TUBING, 1/4" O.D.
2	20 FT.	0302495	CONVOLUTED LOOM, 1/4"
--	--	3014-991015	MANUAL VALVE ASSEMBLY
3	2	0300324	VALVE, SOLENOID AIR CONTROL
4	4	0301207	HOSE ASSEMBLY, 72"
5	4	0301376	CONNECTOR, 8MJ-10MB
6	2	0302677	BREATHER VENT, 1/8 MP
7	4	9010030	ELBOW, 1/4T-1/8MPX
8	1	512-0883000	VALVE, P70
--	--	3014-920000	RECOVERY BOOM ASSEMBLY 3014
9	4	0301388	ELBOW, 8MJ-8MB90
10	2	0302340	BUSHING, HEX (BRASS) 4MP-2FP
11	2	9010030	ELBOW, 1/4T-1/8MPX
12	2	514-1501101	WINCH, 15K DP 15J

Section VI - PARTS (cont'd)

SPADE HYDRAULICS

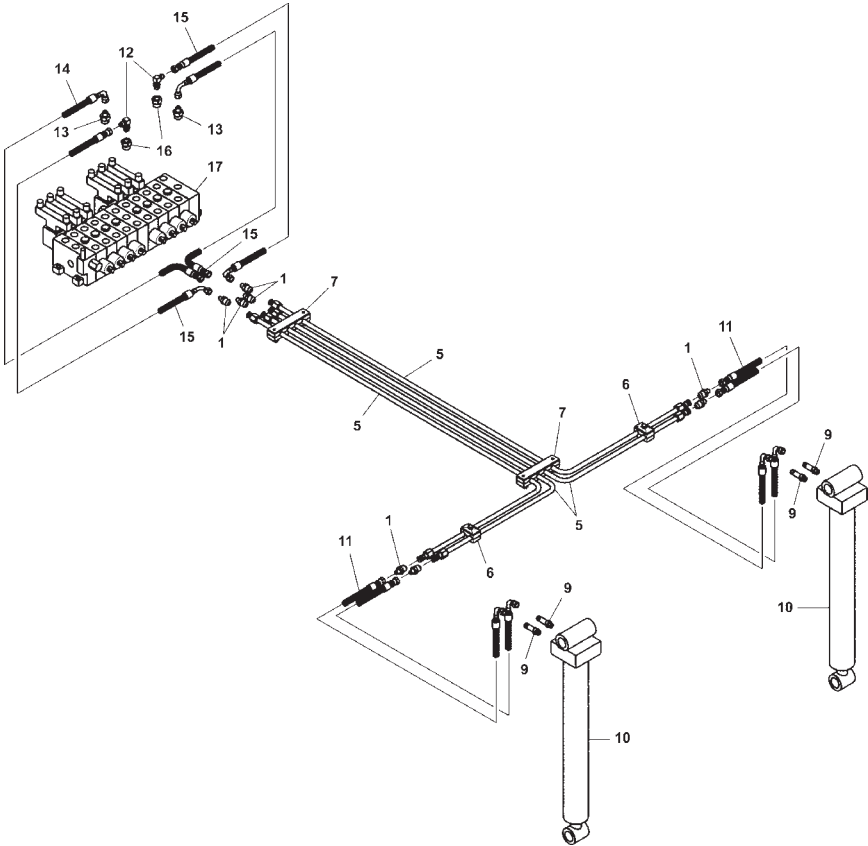

Section VI - PARTS (cont'd)

SPADE HYDRAULICS

REF. NO.	NO. REQ'D	PART NUMBER	DESCRIPTION
--	--	3014-991003	HYDRAULIC TUBING ASSEMBLY
1	8	0302514	ADAPTER, 8MJ-6MJ
2	3	0400070	SCREW, 1/4"-20 X 1" HEX HD CAP (N.S.)
3	3	0400367	NUT, 1/4"-20 HEX NYLOK (N.S.)
4	3	0400451	WASHER, 1/4" FLAT (N.S.)
5	4	516-0806700	HYDRAULIC TUBE ASSEMBLY
6	2	566-0820000	2-TUBE CLAMP SET, 1/2"
7	2	566-0840000	4-TUBE CLAMP SET, 1/2"
8	1	3012-810700	BULKHEAD BRACKET WELDMENT (N.S.)
--	--	3014-991005	JACK ASSEMBLY
9	4	0302510	ADAPTER, 6MJ-6MBL
10	2	511-2500001	CYL, HYD - JACKLEG
11	4	513-0601200	HYD HOSE, 12"
--	--	3014-991015	MANUAL VALVE ASSEMBLY
12	2	0301620	ELBOW, 6MJ-6MB90
13	2	0301778	CONNECTOR, 6MJ-10MB
14	1	0302604	HOSE ASSEMBLY, 44"
15	3	0302926	HOSE ASSEMBLY, 29"
16	1	0303174	CONNECTOR, 10MB-6FB
17	1	512-0883000	VALVE, P70

Section VI - PARTS (cont'd)

MANUAL CONTROL ASSEMBLY

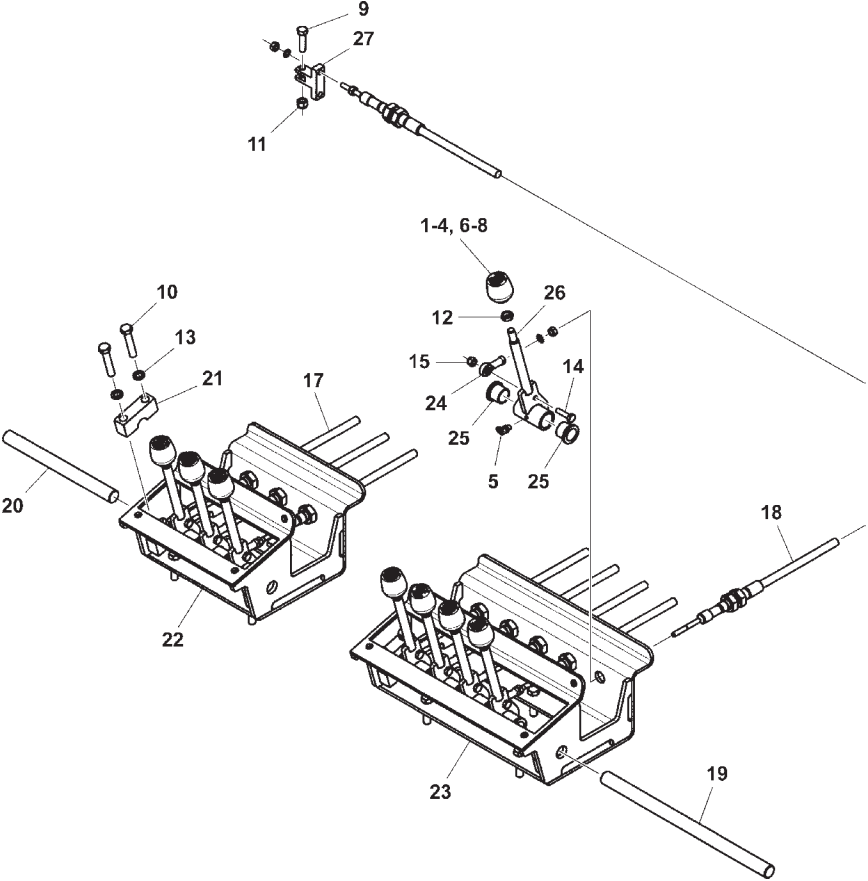

Section VI - PARTS (cont'd)

MANUAL CONTROL ASSEMBLY

REF. NO.	NO. REQ'D	PART NUMBER	DESCRIPTION
1	2	0300834	CONTROL KNOB, (IN/OUT)
2	1	0300835	CONTROL KNOB, BOOM (UP/DOWN)
3	2	0300836	CONTROL KNOB, JACK (UP/DOWN)
4	1	0300837	CONTROL KNOB, BOOM (IN/OUT)
5	8	0302726	GREASE FITTING, 1/4"-28 X 45°
6	1	0302856	CONTROL KNOB, TILT (UP/DOWN)
7	1	0302917	CONTROL KNOB, W/L EXTEND (IN/OUT)
8	1	0303382	CONTROL KNOB, FOLD (UP/DOWN)
9	8	0400103	SCREW, 5/16"-18 X 1-1/4" HEX HD CAP
10	8	0400157	SCREW, 3/8"-16 X 1-3/4" HEX HD CAP
11	8	0400382	NUT, 5/16"-18 HEX
12	8	0400393	NUT, 3/8"-16 HEX JAM
13	8	0400482	LOCKWASHER, 3/8" HELICAL
--	--	3014-991016	CONTROL ASSEMBLY, LH MANUAL
14	8	0400070	SCREW, 1/4"-20 X 1" HEX HD CAP
15	8	0400367	NUT, 1/4"-20 HEX NYLOK
16	3	9024041	SWITCH, MCGILL
17	3	518-0107200	CONTROL CABLE, 6 FT.
18	5	518-0108400	CONTROL CABLE, 7 FT.
19	1	3014-700003	CONTROLS PIN, 12-3/4"
20	1	3014-700004	CONTROLS PIN, 8-3/4"
21	4	3014-798701	RETAINING BLOCK
22	1	3014-887100	FRONT CONTROL BRACKET
23	1	3014-887200	REAR CONTROL BRACKET
24	8	HD0900	BEARING ROD END, 1/4"-28
--	8	3014-987300	CONTROL HANDLE ASSEMBLY
25	2	9053524	FLANGED BEARING
26	1	3014-887300	CONTROL HANDLE WELDMENT
--	--	3014-991015	MANUAL VALVE ASSEMBLY
27	8	3014-791012	CLEVIS, DUAL CONTROL CABLE

Section VI - PARTS (cont'd)

ELECTRIC CONTROL ASSEMBLY

REF. NO.	NO. REQ'D	PART NUMBER	DESCRIPTION
--	--	3014-980400	CONTROL PANEL ASSEMBLY
1	8	0400071	SCREW, 1/4"-20 X 3/4" RD HD PH SS
2	4	0400367	NUT, 1/4"-20 HEX NYLOK
3	4	0402021	SCREW, 1/4"-20 X 1" HEX HD CAP SS
4	8	0402110	WASHER, 1/4" FLAT SS
5	8	0402112	NUT, 1/4"-20 HEX SS
6	2	9024041	SWITCH, MCGILL
7	1	9033575	DECAL, REMOTE
8	1	3014-791015	PANEL, INTERFACE BOX
9	1	3014-797008	CONTROL PANEL
10	2	3014-797011	JOYSTICK MOUNTING PLATE
11	1	3014-797502	ANGLE, RH SWITCH
12	1	522-0112000	SWITCH ASSEMBLY (12)
13	2	522-0712000	JOYSTICK CONTROL, 3014
14	1	536-0200000	DECAL, UP-OUT
15	1	536-0200001	DECAL, IN-DOWN
16	1	536-0200003	DECAL, FRONT WINCH
17	1	536-0200004	DECAL, REAR WINCH
--	--	3014-980020	KIT, CONTROL WIRING ASSEMBLY
18	4	0302380	RELAY, SEALED & SKIRTED
19	2	0307221	JUNCTION BOX, 18 PIN
20	8	0400072	SCREW, 1/4"-20 X 1" RD HD PH
21	8	0400367	NUT, 1/4"-20 HEX NYLOK
22	8	0400481	LOCKWASHER, 3/8" EXT TOOTH

Section VI - PARTS (cont'd)

HYDRAULIC CYLINDERS

REF. NO.	NO. REQ'D	PART NUMBER	DESCRIPTION
1	2	511-2500001 --	CYLINDER, JACK LEG SEAL KIT, JACK LEG CYLINDER
2	1	511-3000001 --	CYLINDER, BOOM EXTENSION SEAL KIT, BOOM EXTENSION CYLINDER
3	1	511-3000002 --	CYLINDER, UNDERLIFT EXTEND SEAL KIT, UNDERLIFT EXTEND CYLINDER
4	2	511-4000001 --	CYLINDER, BOOM LIFT SEAL KIT, BOOM LIFT CYLINDER
5	1	511-5000001 --	CYLINDER, UNDERLIFT FOLD SEAL KIT, UNDERLIFT FOLD CYLINDER

Section VI - PARTS (cont'd)

LIFT FORKS & HOLDERS

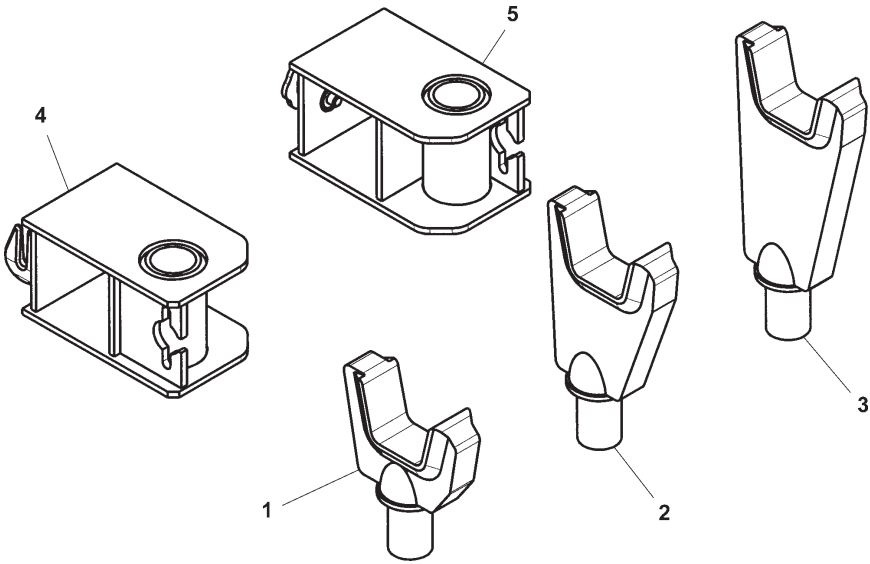

REF. NO.	NO. REQ'D	PART NUMBER	DESCRIPTION
1	2	0200018	FORK, SHORT (3" OPENING)
2	2	0200020	FORK, MEDIUM (3" OPENING)
3	2	0200022	FORK, LONG (3" OPENING)
4	1	896410500	FORK HOLDER WELDMENT, LH
5	1	896417500	FORK HOLDER WELDMENT, RH

Section VI - PARTS (cont'd)

V30 PARTS SHIP KIT

REF. NO.	NO. REQ'D	PART NUMBER	DESCRIPTION
1	1	0307146	SAFETY WALK, 18" X 20'
1	2	9033212	NAME PLATE, VULCAN
--	--	3014-980010	BODY WIRING KIT, V30 SS
1	25	0302433	CABLE TIE
2	1	0303385	JUNCTION BOX, 10 POLE
3	20	0307315	BULLET CONNECTOR, 16-14 VINYL
4	2	526-3014001	WIRING HARNESS, BODY
6	2	526-3014002	WIRING HARNESS, FRONT MARKER
5	2	526-3014003	WIRING HARNESS, BODY EXTENSION
7	2	526-3014004	WIRING HARNESS, STOP & TURN
6	2	526-3014005	WIRING HARNESS, MARKER
8	1	526-3014011	SCHEMATIC, TOOLBOX WIRING
8	1	526-3014012	SCHEMATIC, TOOLBOX WIRING
9	6	GV57	RUBBER GROMMET
--	--	3014-980041	CONTROL PANEL KIT, V30 MANUAL
	10 FT.	0301577	PLASTIC TUBING, 1/4 O.D. BLACK
	1	0302123	NIPPLE, 4MP-4MP HEX
	1	0303363	AIR FILTER/REGULATOR COMBO
	1	0303364	AIR LUBRICATOR
	1	0303365	MOUNTING BRACKET
	1	0307401	UNION, CONVERSION 1/4" X 6MM
	2	9011053	CONNECTOR, 1/4" TUBE X 1/4" MP
11	1	3014-798702	PANEL, LH CONTROL
12	1	526-3014013	SCHEMATIC, LH CONTROL WIRING
13	1	536-0200010	DECAL, LH REAR LOWER
14	1	536-0200011	DECAL, LH REAR UPPER
14	1	536-0200012	DECAL, LH FRONT LOWER
14	1	536-0200013	DECAL, LH FRONT UPPER
14	1	539-6000001	PLASTIC TUBING, AIR LINE 6 MM
	1	HA0132	GAUGE, 0-160 PSI

Section VI - PARTS (cont'd)

3016 COMMON PARTS SHIP KIT

REF. NO.	NO. REQ'D	PART NUMBER	DESCRIPTION
--	--	3014-980014	SHIP KIT, 3014 COMMON PARTS
1	1	0300076	LICENSE PLATE BRACKET
2	3	0300132	CABLE TIE, 15-1/4" BLACK
3	1	0300273	LICENSE PLATE ILLUMINATOR
4	1	0300442	LIGHT, 3 BAR
5	2	0301533	TIE DOWN STRAP, 15"
6	2	0301958	SKUFF PAD, SAFETY CHAIN
7	25	0302433	CABLE TIE
8	2	0500241	DECAL, SAFETY CHAIN WARNING
9	1	0500686	DECAL, RETRACT CAUTION
1	1	0501155	DECAL, DANGER WHEEL LIFT ASSEMBLY
--	--	0900082	HOSE MOUNTING HARDWARE KIT
11	6	0300132	CABLE TIE, 15-1/4" BLACK
12	2	0300134	CLAMP, 1" HOSE INSULATED
13	3	0300188	CLAMP, 1-1/2" HOSE
14	5	0400063	SCREW, 1/4"-20 X 1-1/2" RD HD SLOTTED
15	5	0400366	NUT, 1/4"-20 HEX
16	10	0400451	WASHER, 1/4" FLAT
17	5	0400452	LOCKWASHER, 1/4" HELICAL
--	--	0900174	DASH MOUNT CABLECN HARDWARE KIT
18	2	0400061	SCREW, 1/4"-20 X 3/4" MACH
19	2	0400366	NUT, 1/4"-20 HEX
20	2	0400452	LOCKWASHER, 1/4" HELICAL
21	1	0702227	SWITCH PANEL, MASTER ON/OFF
--	--	0903069	BACK UP ALARM KIT
22	2 FT.	0300077	WIRE, 16 GA RED
23	6	0300153	CONNECTOR, WIRE
24	.25	0301812	HEAT SHRINK TUBE, 1/4"
25	1	0303061	BACK UP ALARM
26	2	0400057	SCREW, 1/4"-20 X 1-1/4" HEX HD CAP
27	2	0400367	NUT, 1/4"-20 HEX NYLOK
28	1	0500676	INSTALL. INSTRUCTION, BACK UP ALARM

Section VI - PARTS (cont'd)

3016 COMMON PARTS SHIP KIT (cont'd)

REF. NO.	NO. REQ'D	PART NUMBER	DESCRIPTION
29	2	9035037	PLASTIC PLUG, 2-3/4"
--	--	3014-980009	CHASSIS INSTALLATION KIT
30	22	0400274	SCREW, 5/8"-11 X 2" HEX HD CAP
31	20	0400416	NUT, 1/2"-13 HEX NYLOK
32	22	0400426	NUT, 5/8"-11 HEX NYLOK
33	40	0400497	WASHER, 1/2" FLAT
34	44	0400502	WASHER, 5/8" EX THK FLAT
35	1	0501421	CHASSIS INSTALLATION SHEET
36	2	3012-780005	MOUNTING ANGLE, CENTER BODY
37	2	3012-880200	FRONT MOUNT
38	2	3012-880300	REAR MOUNTING BRACKET, FORD
39	2	3012-880400	REAR MOUNTING BRACKET, STERLING
40	20	541-5080016	SCREW, 1/2"-13 X 2-1/4" HEX HD CAP
--	--	3014-980011	BODY INSTALLATION KIT
41	8	0400177	SCREW, 1/2"-13 X 1-1/4" HEX HD CAP
42	8	0400237	SCREW, 1/2"-13 X 4" HEX HD CAP
43	12	0400408	NUT, 1/2"-13 HEX NYLOK
44	16	0400467	WASHER, 1/2" FLAT
45	20	0400491	LOCKWASHER, 1/2" HELICAL
46	8	0400497	WASHER, 1/2" ID X 2" OD X .150
47	4	9043830	SCREW, 1/2"-13 X 4-1/2" HEX HD CAP
48	8	9402970	TOOLBOX MOUNTING PAD
49	2	3012-791005	BOX MOUNTING TUBE
50	4	3012-810300	BRACKET, BODY TUBE



8503 Hilltop Drive • Ooltewah, Tennessee 37363 • (423) 238-7227
www.millerind.com